



# CLADE

ASPEN 200KW //

Hydrocarbon AIR SOURCE HEAT PUMPS

March 2023 r2 //



THE ASPEN //



# LOW CARBON HEATING TECHNOLOGY

Clade Hydrocarbon heat pumps will reduce carbon emissions whilst maximising efficiency with existing cooling and heating systems. Our full-service offering makes heat pumps a simple and low risk way to improve your ESG and operational performance.





## TECHNICAL INFORMATION //

Clade Aspen 200kW ASHP		
Nominal conditions: Water side		flow 60c to 45c Return temperature
Nominal conditions: Propane side		Ambient air temperature +3°C (85% RH) and -9°C evaporation
Compressor Manufacturer		Dorin
Compressor Heating Qty	Pcs.	2
Total Power	kW	98.21
Total Amps	A	190.39
Variable speed drive (VSD)	Pcs.	1
Refrigerant charge (R290)	kg	12.5
Electrical supply	-	1~ 400V 50 HZ
Unit Weight (empty)	kg	4,612
Unit Weight (operational)	kg	4,671
Water Volume	L	46
Sound Power	dB(A)	77.9
Sound Pressure 1m	dB(A)	57.5
Sound Pressure 10m	dB(A)	45.3
Connections waterside flow	mm	67
Connections waterside Return	mm	67
Communication protocol	-	BACNET
IP-Class	-	IP54
Evaporators Type		V Block
No. evaporators	Pcs.	6
Fin Material	-	AL/MG
Defrost Type	-	Hot Gas R290
Defrost design/condition	-	> +6c ambient Off Cycle / < +6c ambient Cool Gas
Fan regulation	-	0-10v
Colour	-	Goosewing Grey





## BENEFITS OF THE CLADE ASPEN HC RANGE //

200 KW of heating capacity, single unit for easy installation

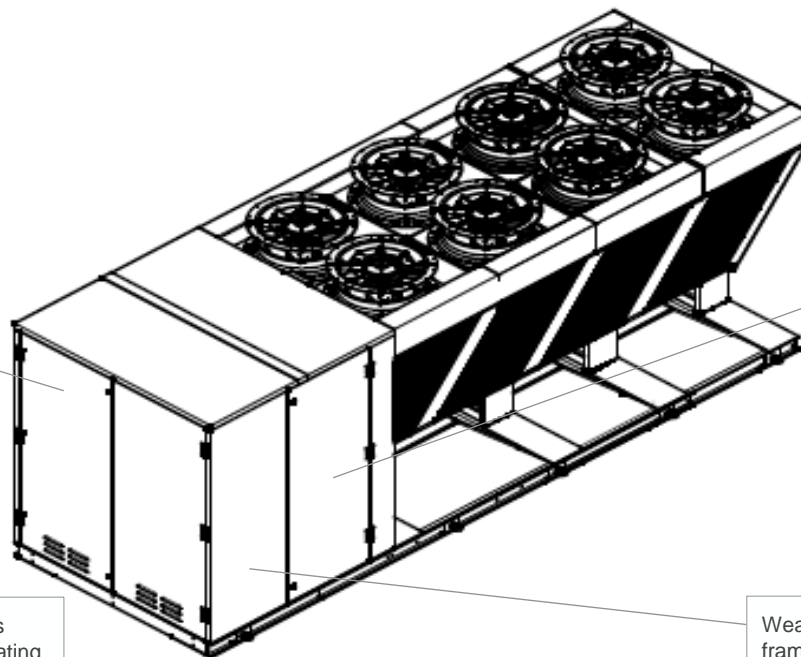

Integrated electrical control panel to work seamlessly alongside client selected BMS system.

Specialist compressors provide a greater operating temperature range and increased COP.

All components are easily accessible for quick and effective maintenance.

Weather proof housing and galvanised lifting frame for easy positioning on site





## DIMENSIONAL INFORMATION //

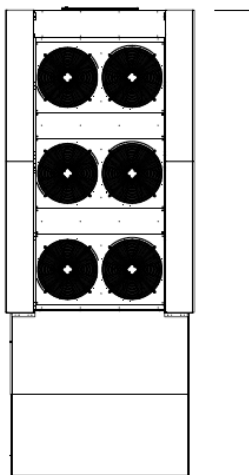
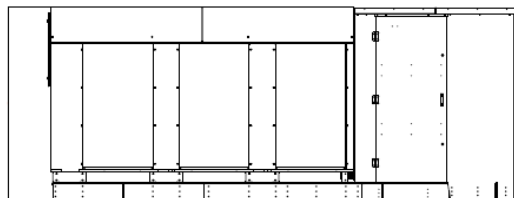
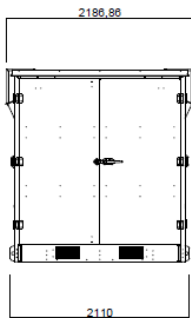

APPROX WEIGHT = 4671Kg

DIMENSIONED OUTSIDE (mm) UNLESS STATED

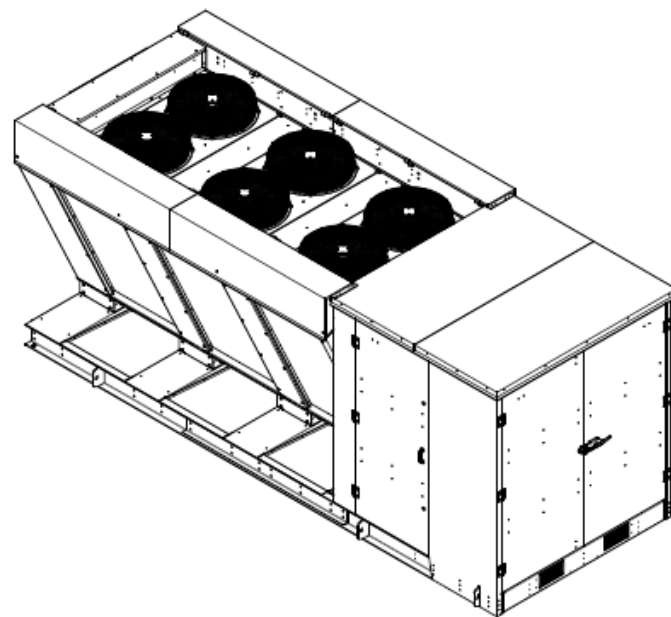



# PERFORMANCE //

Aspen 200kW Heat Pump Performance Characteristics - v1																													
Model name	Nameplate output (kW)	Output Temp (°C)	Return Temp (°C)	SCOP	SPF	-10°C External			-5°C External			0°C External			5°C External			10°C External			15°C External			20°C External			25°C External		
						QH (kW)	PI (kW)	COP H (-)	QH (kW)	PI (kW)	COP H (-)	QH (kW)	PI (kW)	COP H (-)	QH (kW)	PI (kW)	COP H (-)	QH (kW)	PI (kW)	COP H (-)	QH (kW)	PI (kW)	COP H (-)	QH (kW)	PI (kW)	COP H (-)	QH (kW)	PI (kW)	COP H (-)
Aspen 200 kW	200.00	60	40	2.9	3	160	62	2.59	200	73	2.72	210	73	2.87	220	71	3.08	240	73	3.31	240	66	3.64	240	62	3.88	240	62	3.88
		55	35	3	3.1	160	56	2.87	200	68	2.93	210	68	3.08	220	66	3.33	240	66	3.64	240	61	3.96	240	57	4.23	240	57	4.23
		50	35	3.2	3.3	160	54	2.99	200	65	3.07	210	64	3.26	220	62	3.53	240	62	3.90	240	55	4.36	240	52	4.60	240	52	4.60
		45	30	3.4	3.5	160	49	3.24	200	60	3.35	210	59	3.56	220	56	3.92	240	55	4.37	240	49	4.94	240	46	5.21	240	46	5.21

## BUILDING CONNECTIONS //

### POWER

3 phase.

Connection box mounted in position shown.

Isolation at control panel only.

Installer to provide local isolator external to heat pump.

### HEATING

Supplied with primary pump with ~14m spare head.

Flow and return located in position shown.

### CONDENSATE

Condensate from the evaporator will drain centrally from the base of the unit.

It is recommended that a gully be installed below the heat pump and lead to a soak away.

### CONTROLS

The heat pump has self contained controls that manage its operation and the primary pump.

#### Alarms

- Hardwired shut down signal for fire alarm
- CO<sub>2</sub> detection
- Other fault
- High return water temperature.

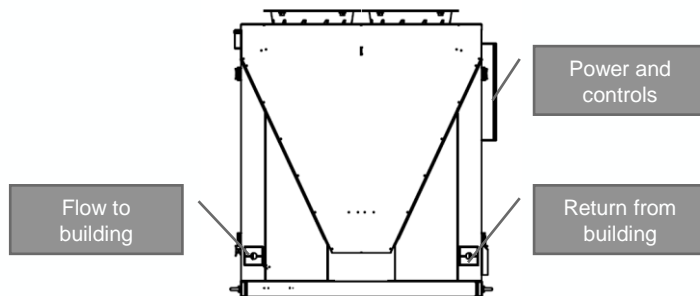

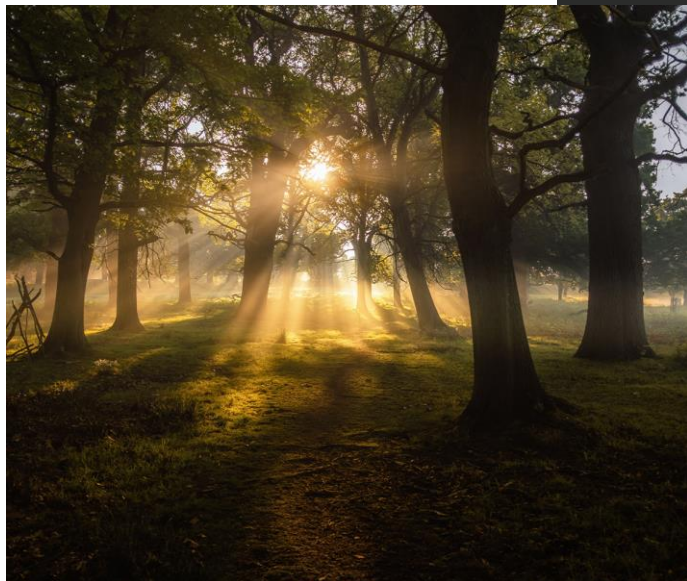

———— THANK YOU //

[www.clade-es.com](http://www.clade-es.com)

[Sales@clade-es.com](mailto:Sales@clade-es.com)

[Aftersales@clade-es.com](mailto:Aftersales@clade-es.com)

Head Office & Registered Office //  
Bristol & Bath Science Park,  
Dirac Crescent, Emersons Green,  
BRISTOL BS16 7FR

The Technology Centre //  
Unit R3 Gildersome Spur Industrial Estate,  
Stone Pits Lane, Morley,  
LEEDS LS27 7JZ

